

## Reference Diagram for Mounting

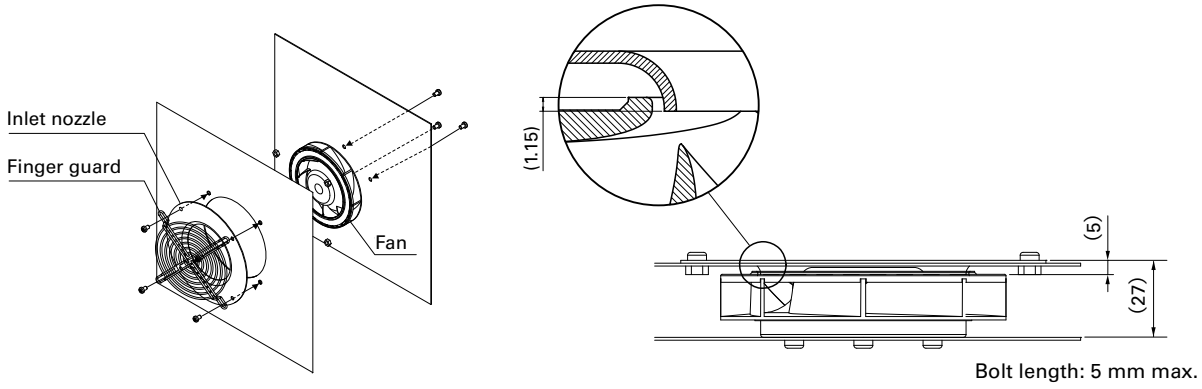

## Airflow - Static Pressure Characteristics

### PWM Duty Cycle

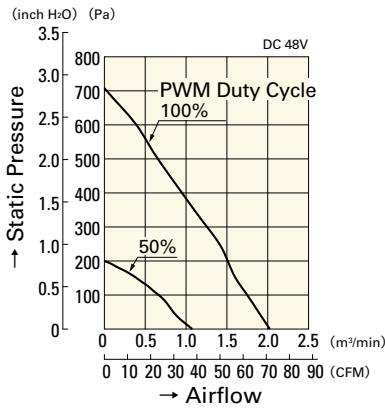

**9W1TM48P4G01**

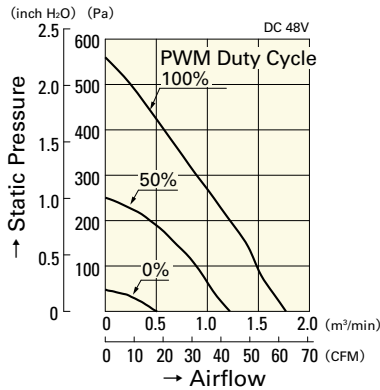

**9W1TM48P4H01**

### Operating Voltage Range

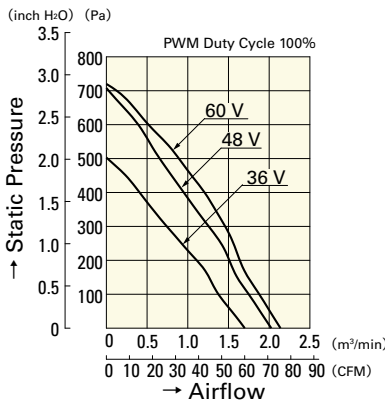

**9W1TM48P4G01**

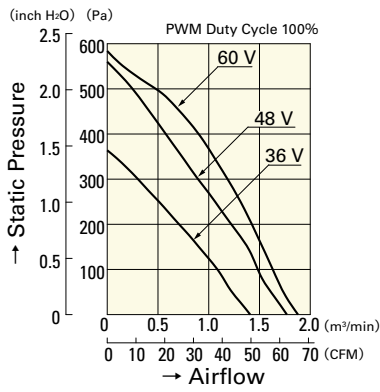

**9W1TM48P4H01**

## PWM Duty - Speed Characteristics Example

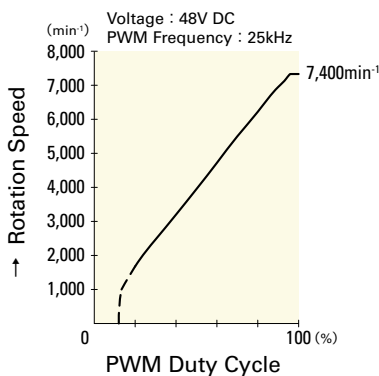

**9W1TM48P4G01**

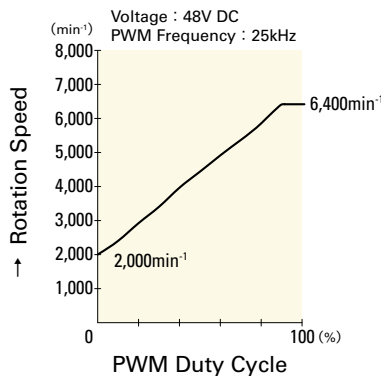

**9W1TM48P4H01**